

Ø4,3

25

Luftstrom
airflow

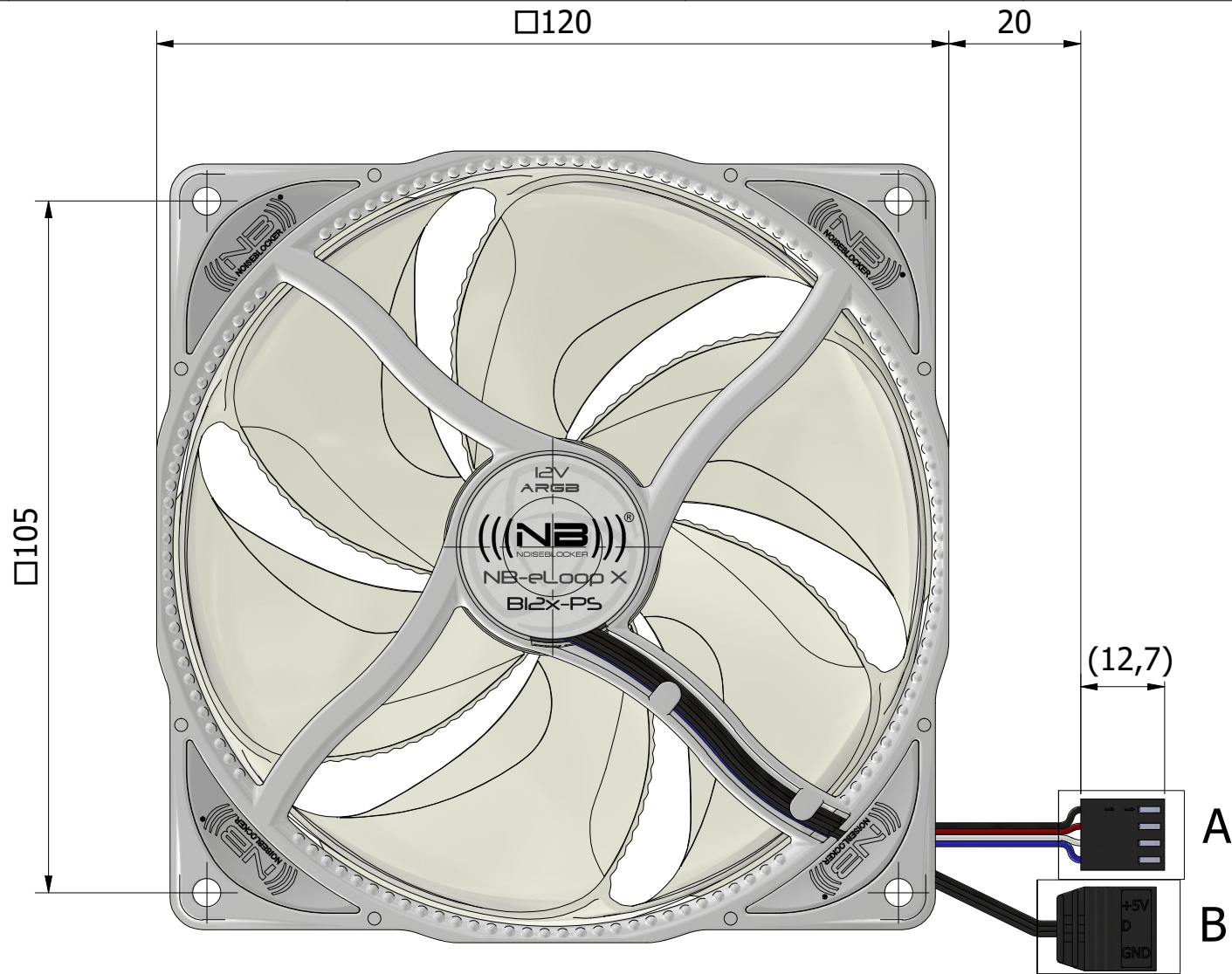

□120

20

□105

(12,7)

A

B

Rotation
rotation



B (2 : 1)
aRGB connector

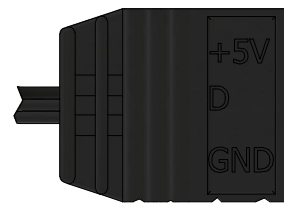

A (2 : 1)
KK 254 Crimp Housing or similar

- Pin1 (schwarz) - Masse
- Pin 1 (black) - ground
- Pin 2 (rot) - Spannung
- Pin 2 (red) - voltage
- Pin 3 (weiß) - Tacho
- (für Betrieb nicht erforderlich)
- Pin 3 (white) - tachometer
- (not needed to run)
- Pin 4 (blau) - PWM-Signal
- Pin 4 (blue) - PWM-signal

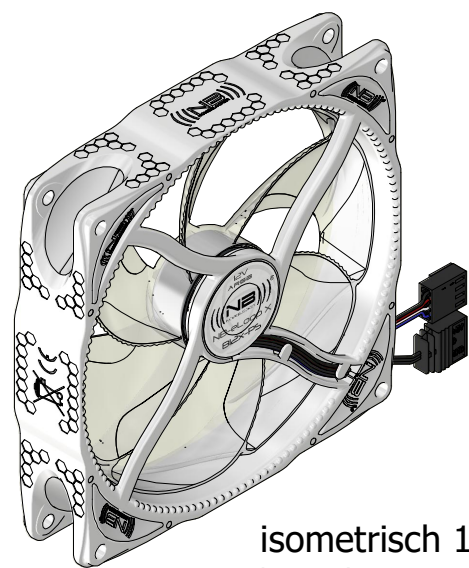

isometrisch 1:2
isometric

technische Spezifikationen
technical specifications

Drehzahl: rotation speed:	400 - 1500 U/min
Lagerart: bearing type:	NB-NanoSLI® 2
Steuerung: control:	25 kHz PWM

Allgemeintoleranzen: general tolerances:	---	Maßstab: size:	1 : 1	Blatt: sheet:	1/1	Zubehör: accessories:	Montageset, Kabelmanagementset mounting kit, cable management kit
Oberflächenangaben: surface data:	---	A3	Metrisch metric			Material: material:	---
Schutzvermerk: protection note:	DIN ISO 16016	Datum / date		Name		Art.-Nr.: part no.:	12NBR12251542
Weitergabe sowie Vervielfältigung dieses Dokuments, Verwertung und Mitteilung seines Inhalts sind verboten, soweit nicht ausdrücklich gestattet. Zuwiderhandlungen verpflichten zu Schadenersatz. Alle Rechte für den Fall der Patent-, Gebrauchsmuster- oder Geschmacksmustereintragung vorbehalten.		Angelegt created	20.04.2023	TW		Zeich.-Nr.: draw no.:	499 1225 15
The reproduction, distribution and utilization of this document as well as the communication of its contents to others without express authorization is prohibited. Offenders will be held liable for the payment of damages. All rights reserved in the event of the grant of a patent, utility model or design.		Bearbeitet changed	21.04.2023	TW		Art.-Nr. Kunde: part no. cust.:	B12x-PS
		Geprüft checked	21.04.2023	TW		Bezeichnung: name:	NB-eLoop DC 12 V Axiallüfter 120x120x25 mm NB-eLoop DC 12 V axial fan 120x120x25 mm
		BLACKNOISE technology group					
		www.blacknoise.com					

NUR ZUR INFORMATION
UNTERLIEGT NICHT DEM ÄNDERUNGSDIENST!

ONLY FOR INFORMATION
IS NOT SUBJECT OF THE REVISION SERVICE!